

**NO
MORE
DIGGING!**

Concrete Free Footings



SUREFOOT PRODUCT BROCHURE 2025



ENGINEERS
AUSTRALIA

1300 64 64 23
nomoredigging.com.au



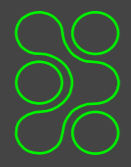

T150 3W – 35kn

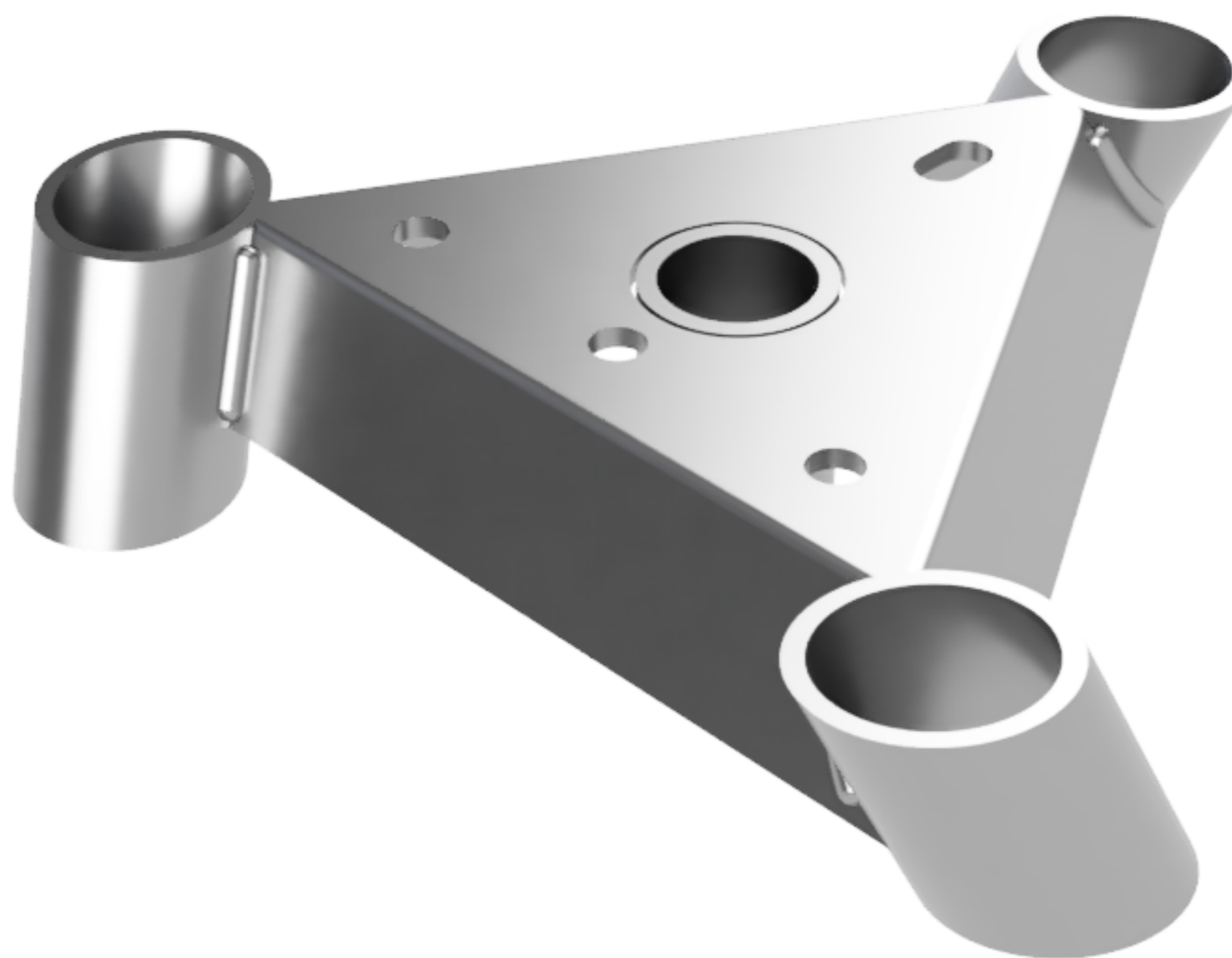

Bolting Pattern
147mm x 3 x 16mm Holes

Micro Piles
3 x 32NB (Nomial Bore) 42.4OD Galvanised Light, Medium & Heavy

Load Capacity
Up to 35kn

Average installation time
20 Minutes approx.

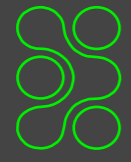

S150 4W - 25kn

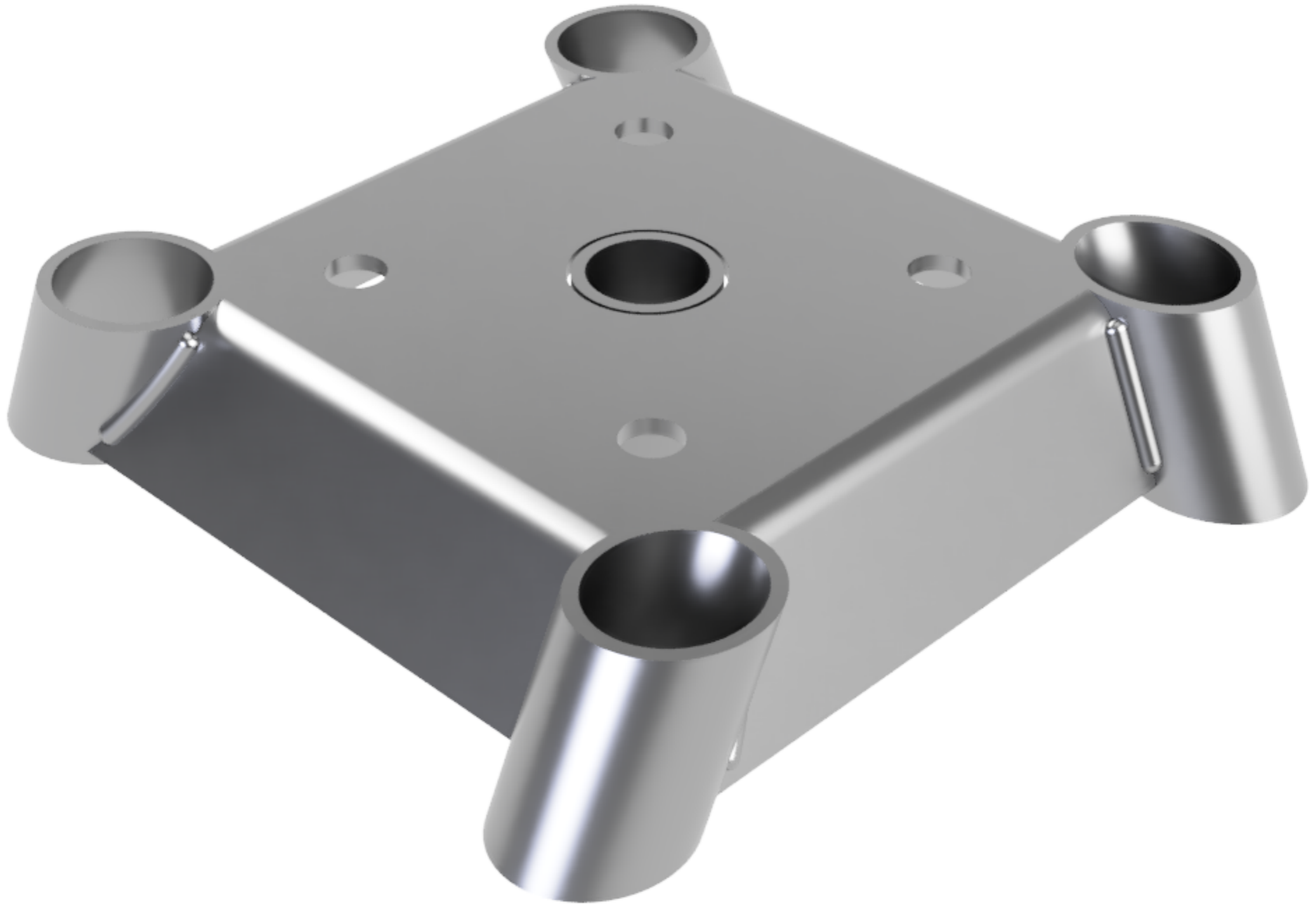

Bolting Pattern
147mm x 4 x 16mm Holes

Micro Piles
4 x 25mmNB (Nomial Bore) 33.7 x 2.6mm thick

Load Capacity
Up to 25kn

Average installation time
20 Minutes approx.

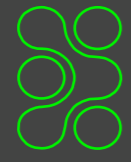

S250 3W – 75kn



Bolting Pattern(s)

140mm centres x 4 x 22mm holes / 120mm centres x 4 x 18mm holes

Micro Piles

4 x 32mmNB (Nomial Bore) 42.4OD Galvanised

Load Capacity

Up to 75kn

Average installation time

20 Minutes approx.

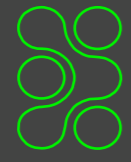

S250 4P – 75kn

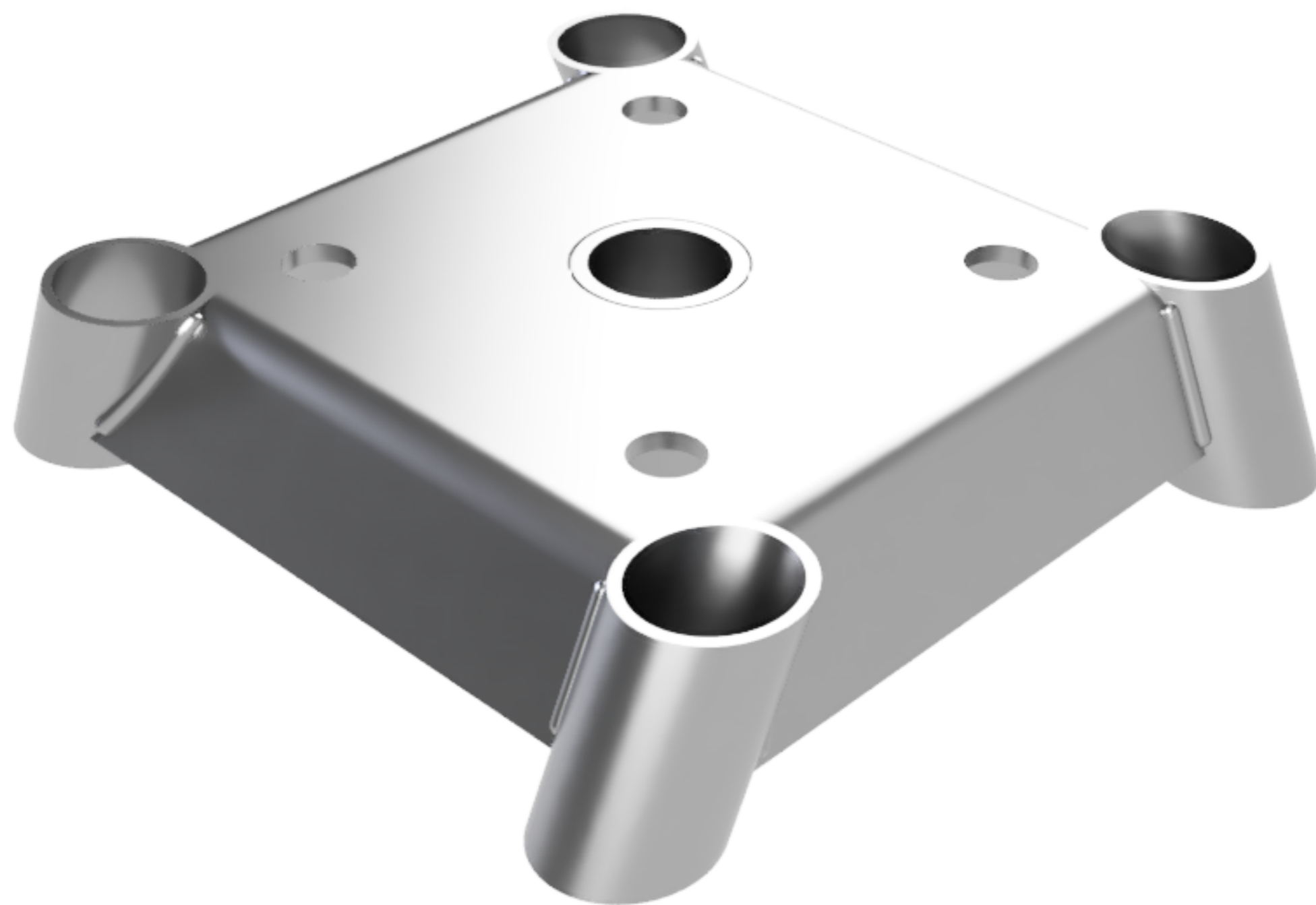

Bolting Pattern(s)
140mm centres x 4 x 22mm holes

Micro Piles
4 x 32mmNB (Nomial Bore) 42.4OD Galvanised

Load Capacity
Up to 75kn

Average installation time
20 Minutes approx.

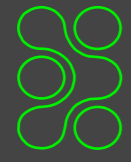

S250 8P – 100kn



Bolting Pattern(s)

140mm centres x 4 x 22mm holes / 120mm centres x 4 x 18mm holes

Micro Piles

6 x 32mmNB (Nomial Bore) 42.4OD Galvanised

Load Capacity

Up to 100kn

Average installation time

30 Minutes approx.

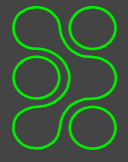

S400 12P – 200kn



Bolting Pattern(s)

198-250 PCD x 4 x 22mm holes / 300-350 PCD x 4 x 26mm holes

Micro Piles

12 x 32mmNB (Nomial Bore) 42.4OD Galvanised

Load Capacity

Up to 200kn

Average installation time

30 Minutes approx.

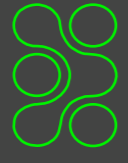

S600 12P - 200kn

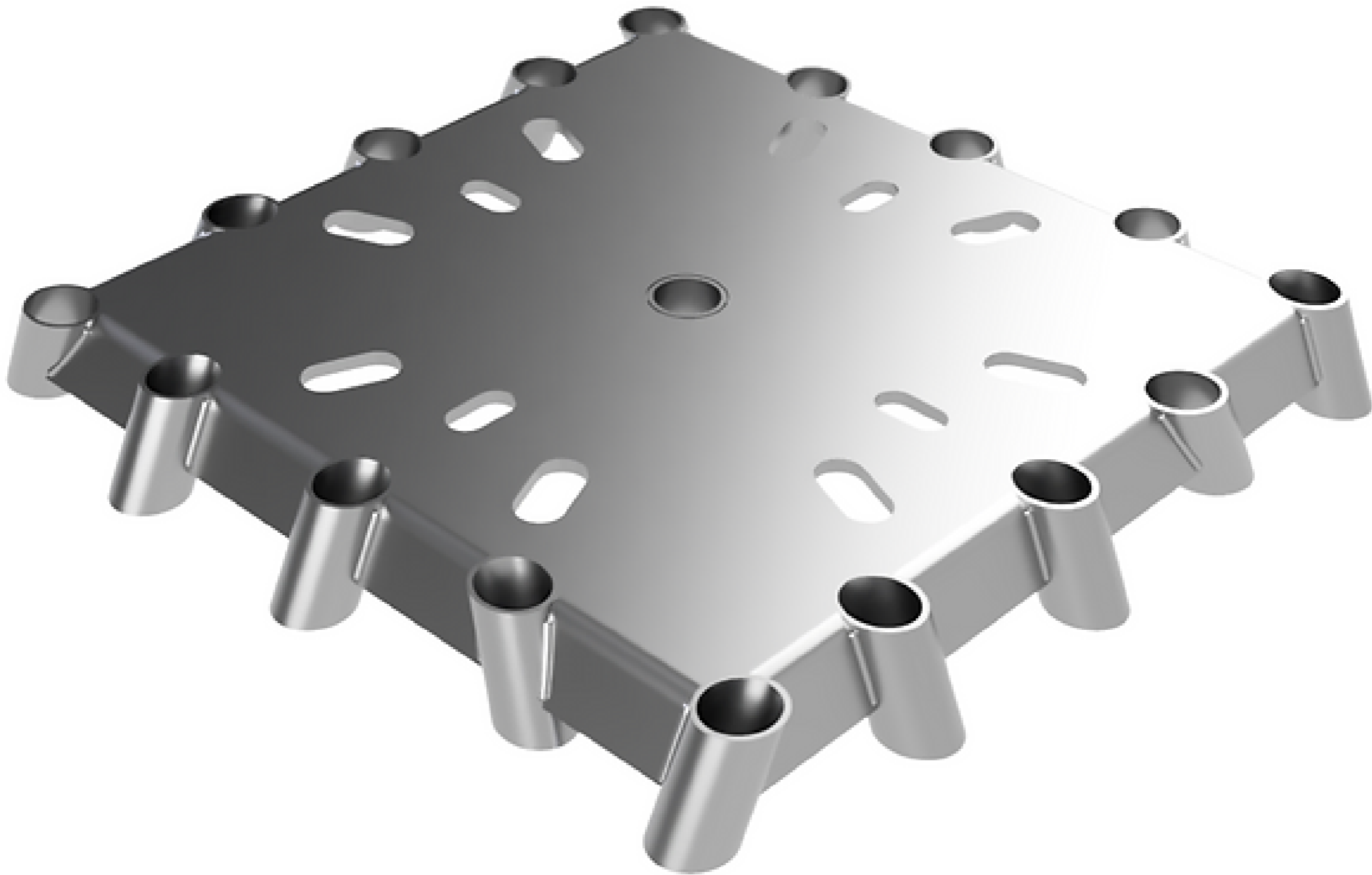

Bolting Pattern(s)

350-400 PCD x 4 x 26mm holes / 432-500 PCD x 4 x 26mm holes

Micro Piles

16 x 32mmNB (Nomial Bore) 42.4OD Galvanised

Load Capacity

Up to 300kn

Average installation time

45 Minutes approx.

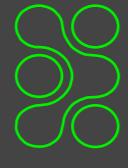

CONNECTIONS

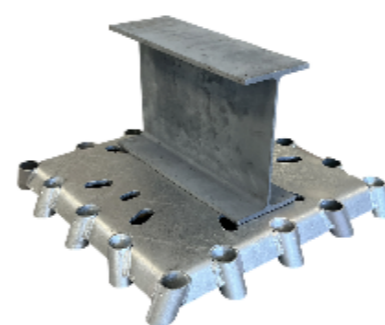
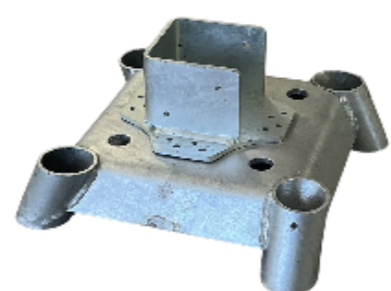
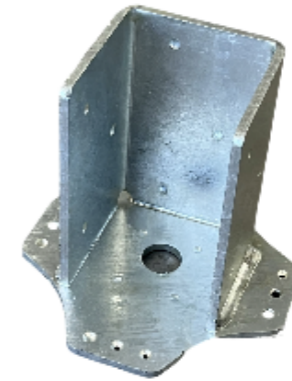
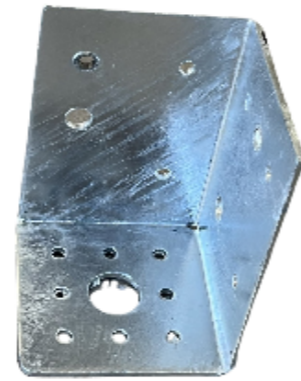
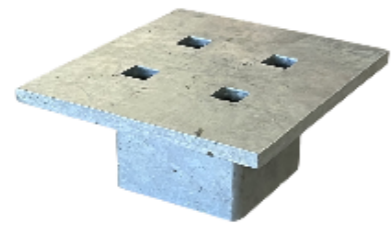
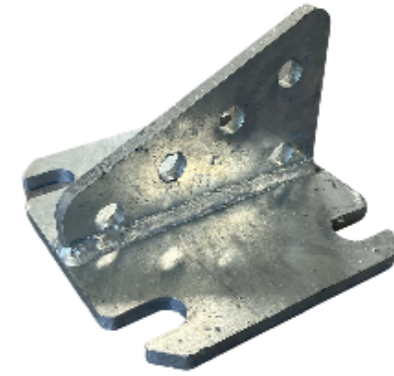



**Simplify the difficult
with SUREFOOT!**

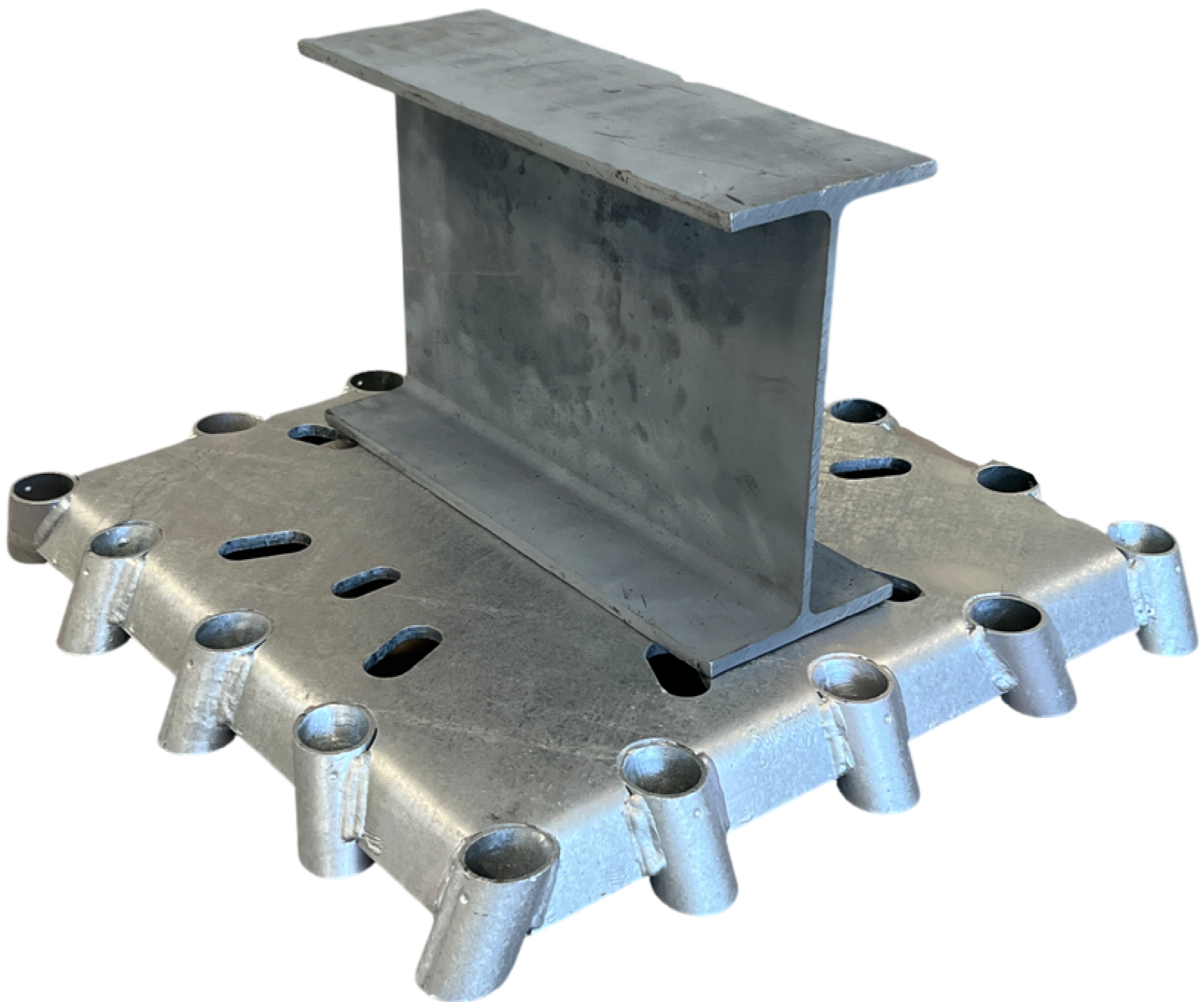

1300 64 64 23
nomoredigging.com.au